

Article number: 20146B30562SW

Description: E+G

Flanged Connector GN 146-B30-56-2-SW

Measures

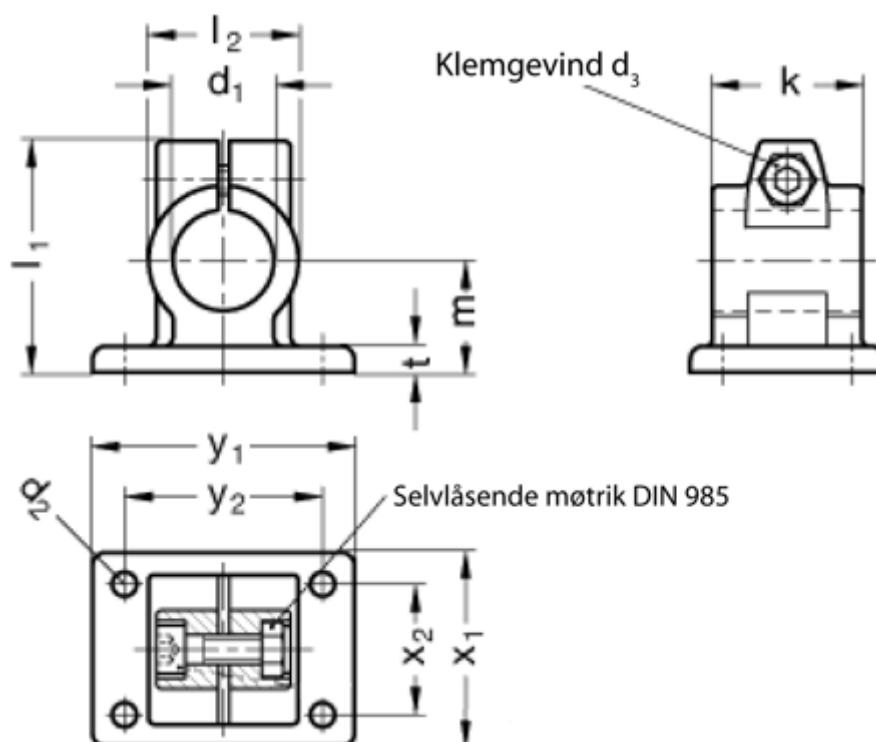

Adjustable clamp lever = GN 911-M10-40 have to be ordred separately

d1	= B30
d2	= 8.5
d3	= M10
k	= 56
l1	= 83
l2	= 56
m	= 42

t	= 10
x1	= 78
x2	= 52
y1	= 108
y2	= 82